



TROJAN™

20 KG ADJUSTABLE DUMBBELL SET

4 X 1 KG
PLATES

2 X 1.25 KG
PLATES

4 X 2.5 KG
PLATES

2 X 355 MM
DUMBBELL HANDLES

STRENGTH
& TONING



USER MANUAL

Includes:

- 4 x 1 kg Plates
- 2 x 1.25 kg Plates
- 4 x 2.5 kg Plates
- 2 x 355 mm (L) Dumbbell Handles
(25.4 mm diameter with 4 spin lock collars)

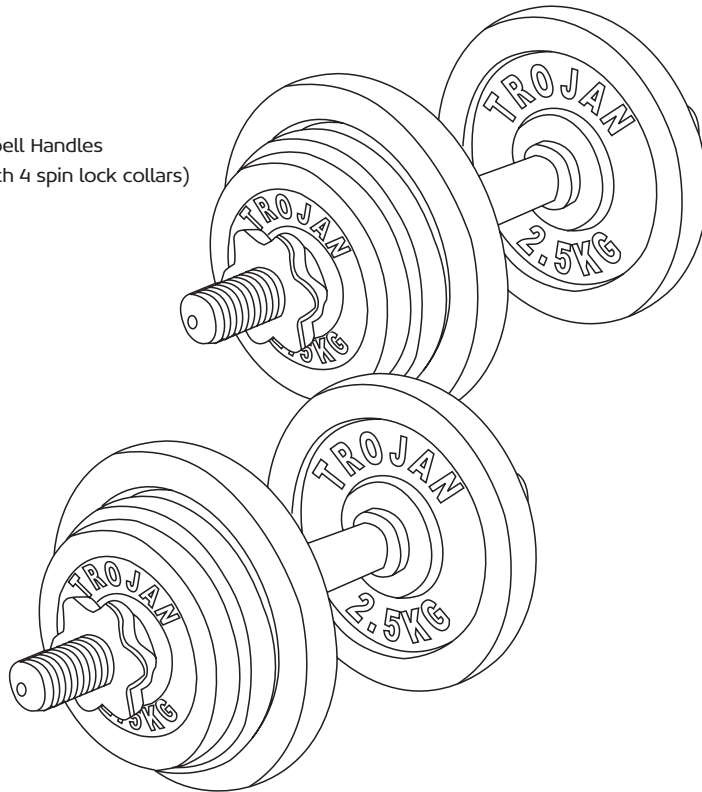

CAUTION

READ ALL PRECAUTIONS AND INSTRUCTIONS IN THIS MANUAL BEFORE USING THIS EQUIPMENT. KEEP THIS MANUAL FOR FUTURE REFERENCE.

Visit facebook.com/trojanhealth
www.trojanhealth.co.za
www.instagram.com/trojanhealth





INDEX

- **Important Safety Instructions** _____ 3
- **Exercises** _____ 5
- **Exercise Instructions** _____ 10
- **Maintenance** _____ 11
- **Fitness Tips & Techniques** _____ 12
- **Conditioning Guidelines** _____ 13
- **Warm Up & Cool Down** _____ 14
- **2 Year Limited Warranty** _____ 15
- **Repairs Procedure** _____ 16

IMPORTANT SAFETY INSTRUCTIONS

It is the sole responsibility of the purchaser of Trojan products to read the owner's manual, warning labels and instruct all individuals, on proper usage of the equipment. Understanding each and every warning to the fullest is important. If any of these instructions or warnings are unclear please contact Trojan Customer Services on **0861 TROJAN (0861 876526)**, within the Republic of South Africa. Customers residing outside South Africa can contact us on +27 10 206 4405.

The equipment is only intended for home use and is not intended for commercial, institutional and/or studio facilities use.

Contact Trojan with any questions regarding this classification. It is recommended that all users of Trojan be informed of the following information prior to use.



HEALTH WARNING

- Before starting any exercise or conditioning program you should consult with your personal physician to see if you require a complete physical exam. This is especially important if you are inactive, pregnant or suffer from any illness.
- If at any time during exercise you feel faint, dizzy or experience pain, stop exercising immediately and consult your physician.
- To avoid muscular pain and strain, begin each workout by stretching and warming up and end each session by cooling down and stretching.



PROPER USAGE

- Do not use the equipment in any way other than as designed or intended by the manufacturer. It is imperative that Trojan equipment is used properly to avoid injury.
- Injuries may result from exercising improperly or excessively.
- Repairs other than the procedures in this manual should be performed by an authorised service representative only.



ACCESS CONTROL

- Trojan recommends that all fitness equipment be used in a supervised area. It is recommended that the equipment be located in an access controlled area. Control is the responsibility of the owner. Keep children away from all equipment.
- Parents or others supervising adults must provide close supervision of children if the equipment is used in the presence of children.

IMPORTANT SAFETY INSTRUCTIONS

INSPECTION

- Do not use or permit use of any equipment that is damaged, or has worn or broken parts. For all Trojan equipment use only replacement parts supplied by Trojan.
- Maintain labels and nameplates – do not remove labels for any reason. They contain important information.
- Equipment maintenance – preventative maintenance is the key to smooth operating equipment. Please ensure that you follow our maintenance tips to ensure the continued correct function of your Trojan equipment.
- Before any use, examine all accessories approved for use with the Trojan equipment for damage or wear.
- Should your Trojan equipment appear damaged or worn, do not attempt to use or repair the equipment yourself.
- Please contact our service department on **0861 TROJAN (0861 876526)** to arrange a repair. Customers residing outside South Africa can contact us on +27 10 206 4405.

OPERATING WARNINGS

- It is the purchaser's responsibility to instruct all users as to the proper operating procedures of all Trojan equipment.
- Keep children away from all moving parts. Parents must provide close supervision of children if the equipment is used in the presence of children.
- Do not wear loose fitting clothing or jewellery when using the equipment. It is also recommended that users tie up long hair to avoid contact with moving parts.

SAVE THIS INSTRUCTION MANUAL FOR FUTURE USE AND REFERENCE.

If any of these instructions or warnings are unclear please contact Trojan Customer Services on **0861 TROJAN (0861 876526)** within the Republic of South Africa or **visit www.trojanhealth.co.za**. Customers residing outside South Africa can contact us on +27 10 206 4405.

Thank you for choosing the Trojan 20 kg Adjustable Dumbbell Set. We take great pride in producing this product and hope it will provide many hours of quality exercise to make you feel better, look better and enjoy life to its fullest. Yes, it's a proven fact that a regular exercise program can improve your physical and mental health. Too often, our busy lifestyles limit our time and opportunity to exercise. Begin your assault on getting your body in shape and achieving a healthier lifestyle. Before reading further, please review the drawing below and familiarise yourself with the parts that are labelled.

Read this manual carefully before using the 20 kg Adjustable Dumbbell Set.

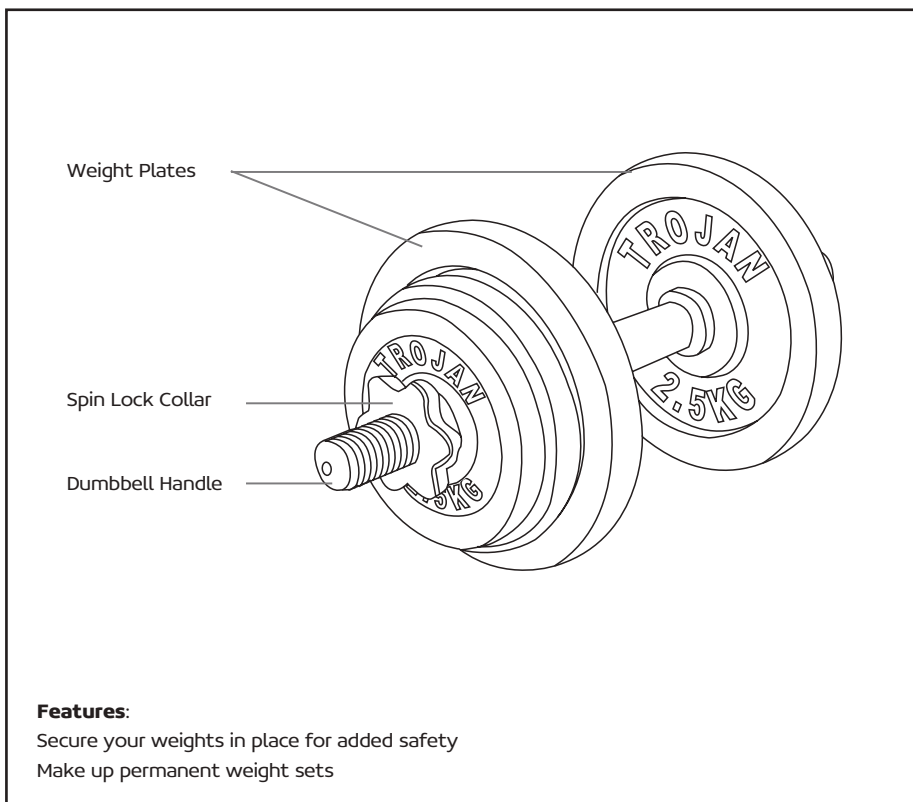

EXERCISES

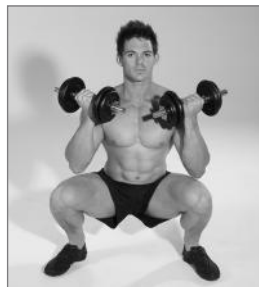
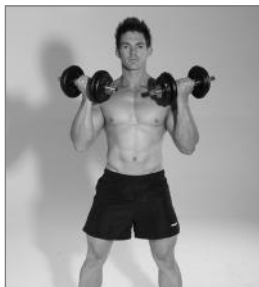

SQUAT

Stand holding the dumbbells in the curl position, with feet shoulder width apart. Lower yourself down into a squat position, then slowly raise your body back to the standing position.

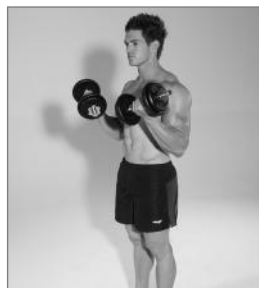
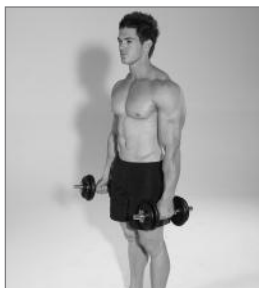

DOUBLE BICEP CURLS

This exercise can be performed seated or standing. Hold a dumbbell in each hand using the underhand grip. Curl the dumbbell upwards as far as possible then lower it slowly to your side.



BENT OVER FLY

This exercise can be performed seated or standing. Hold a dumbbell in each hand using the overhand grip. Bend your body until your back is parallel to the ground. Keep your back straight. Raise both arms out to the side to shoulder height. Lower your arms to the starting position.



TRICEP EXTENSIONS

This exercise can be performed seated or standing. Each arm is exercised separately. Hold the dumbbell above your head keeping your arm in place with your other hand. Bend your arm at the elbow allowing the weight to be lowered behind your head, then extend the arm pushing the weight to the starting position.

EXERCISES

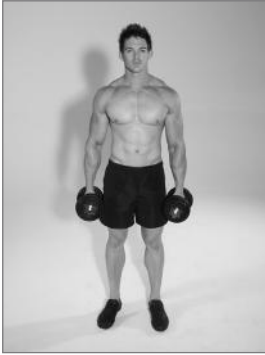

SIDE RAISES

Stand with feet shoulder width apart. Hold the dumbbells at your sides with an overhand grip. Keeping your arms straight lift both dumbbells out to the side and upwards stopping when they are level with your head. Slowly return them to the starting position.



LUNGE

Hold a dumbbell in each hand with your arms to your side. Place your one foot a pace forward. Then, lower your body directly down into the lunge position, stopping just before the knee touches the ground. Return to the starting position.

EXERCISES

Using your dumbbells with an Exercise Bench will provide you with a range of different exercises. This will improve your overall exercise routine.

(Note: the bench is sold separately).



SEATED SIDE RAISES

Sit on a bench. Hold the dumbbells at your sides with an overhand grip. Keeping your arms straight lift both dumbbells out to the side and upwards stopping when they are level with your head. Slowly return them to the starting position.



DUMBBELL ROWS

In this exercise each side of the body is exercised separately. Lean forward and place one knee and one hand on the bench. With a straight arm hold the dumbbell using an overhand grip. Pull the dumbbell up towards your chest as far as possible and slowly lower it to the starting position.

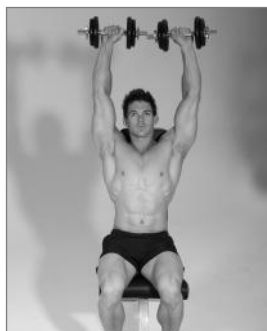
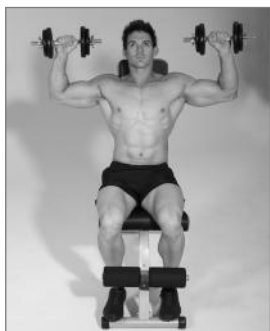

SEATED DUMBBELL PRESS

Sit on a bench at 90° with a dumbbell in each hand, using an overhand grip. Hold the weights above your chest with your arms straight. Keeping the elbows out lower the weights as far as possible, then press them back to the starting position.

EXERCISES



TRICEP EXTENSION

Lie on your back on a bench with a dumbbell in each hand, palms facing each other. Hold the weights above your chest with your arms straight. Keeping the elbows out, lower the weights over your head as far as possible, then press them back to the starting position.



PULL OVER

Lie with your back resting on a bench (as shown) with one dumbbell held in both hands. Hold the weights above your chest with your arms slightly bent. Lower the weight over your head with straight arms until they are parallel to your chest, then bring them back above the chest.



CONCENTRATION CURLS

Sit on a bench with legs apart. Hold a dumbbell in the curl position and rest your elbow on the inside of your thigh (as shown). Start with your arm straight down and curl toward your chest. Alternate each arm.



INCLINE DUMBBELL CURLS

This exercise can be performed seated or standing. Hold a dumbbell in each hand using the underhand grip. Curl the dumbbell upwards as far as possible then lower it slowly to your side. As one dumbbell is being lowered the other should be raised.

EXERCISES

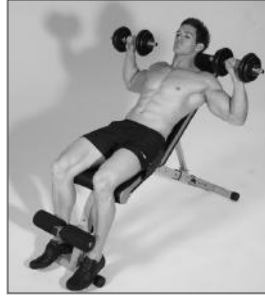

INCLINE DUMBBELL PRESS

Lie on your back on a 45° bench with a dumbbell in each hand, using an overhand grip. Hold the weights above your chest with your arms straight. Keeping the elbows out lower the weights as far as possible, then press them back to the starting position.



DUMBBELL FLYES

Lie on your back on a bench with a dumbbell in each hand, palms facing each other. Hold the weights above your chest with your arms slightly bent. Lower the weights to the side as far as possible and then bring them back above the chest.



DUMBBELL BENCH PRESS

Lie on your back on a bench with a dumbbell in each hand, using an overhand grip. Hold the weights above your chest with your arms straight. Keeping the elbows out lower the weights as far as possible, then press them back to the starting position.

EXERCISE INSTRUCTIONS

Using your Dumbbell Set provides you with several benefits. It will improve your physical fitness, tone muscle and in conjunction with calorie controlled diet help you lose weight.

THE WARM UP PHASE

This stage helps get the blood flowing around the body and the muscles working properly. It will also reduce the risk of cramp and muscle injury. It is advisable to do a few stretching exercises as shown below. Each stretch should be held for approximately 30 seconds, do not force or jerk your muscles into a stretch. If it hurts, **STOP**.



SIDE BENDS



FORWARD BENDS



OUTER THIGH



INNER THIGH

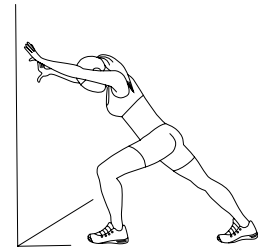

CALF STRETCH

CONDITIONING GUIDELINES

How you begin your exercise program depends on your physical condition. If you have been inactive or are severely overweight, you must start slowly and increase your time on the equipment by a few minutes per workout.

Initially, you may be able to exercise only for a few minutes in your target zone, however, your fitness will improve over the next six to eight weeks. Don't be discouraged if it takes longer. It's important to work at your own pace.

Eventually, you'll be able to exercise continuously for 30 minutes. The better your fitness, the harder you will have to work to stay in your target zone. Please remember these essentials :

- Have your doctor review your training and diet programs to advise you of a workout routine you should adopt.
- Begin your training program slowly with realistic goals that have been set by you and your doctor.
- Monitor your pulse frequently. Establish your target heart rate based on your age and condition.

WEIGHT LOSS

The important factor here is the amount of effort you put in. The harder and longer you work the more calories you will burn.



MAINTENANCE

CLEANING

The Dumbbell Set can be cleaned with a soft cloth and mild detergent. Do not use abrasives or solvents on plastic parts. Wipe any perspiration off the set after each use.

STORAGE

Store your Dumbbell Set in a clean and dry environment away from children.

FITNESS TIPS & TECHNIQUES

AEROBIC EXERCISE

Aerobic exercise is any sustained activity that sends oxygen to your muscles via your heart and lungs. Aerobic exercise improves the fitness of your lungs and heart – your body's most important muscle. Aerobic exercise fitness is promoted by any activity that uses your large muscles (arms, legs, or buttock, for example). Your heart beats quickly and you breathe deeply. An aerobic exercise should form part of your entire exercise routine.

WEIGHT TRAINING

Along with aerobic exercising which helps get rid of and keep off the excess fat that our bodies can store, weight training is an essential part of the exercise routine process. Weight training helps tone, build and strengthen muscle. If you are working above your target zone, you may want to do a lesser amount of reps. Always consult your physician before beginning any exercise program.

MUSCLE CHART

20 KG ADJUSTABLE DUMBBELL

The exercise routine that is performed on the 20 Kg Adjustable Dumbbell will develop the entire body muscle group as well as condition the circulatory system and provide a good workout. These muscle groups are highlighted on the muscle chart below.

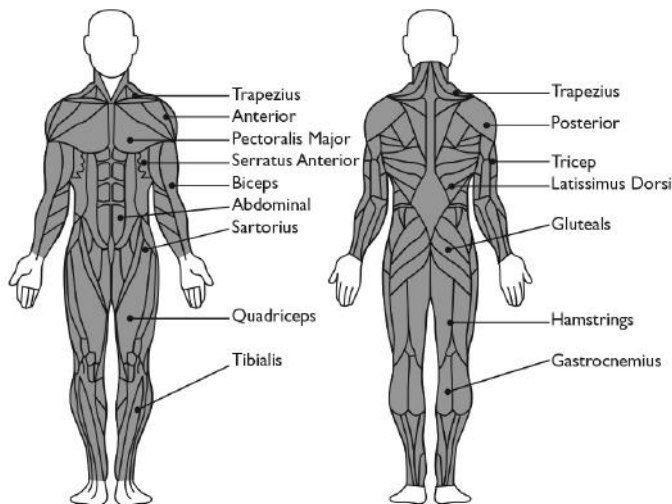

VISIT:
www.trojanhealth.co.za for equipment choices and exercise programs

CONDITIONING GUIDELINES

EXERCISE INTENSITY

To maximise the benefits of exercising, it is important to exercise with the proper intensity. The proper intensity level can be found by using your heart rate as a guide. For effective aerobic exercise, your heart rate should be maintained at a level between 65% and 85% of your maximum heart rate as you exercise. This is known as your target zone. You can find your target zone in the table below.

During the first few months of your exercise program, keep your heart rate near the low end of your target zone as you exercise. After a few months, your heart rate can be increased gradually until it is near the middle of your target zone as you exercise.

To measure your heart rate, stop exercising but continue moving your legs or walking around and place two fingers on your wrist. Take a six second heartbeat count and multiply the results by 10 to find your heart rate. For example, if your six second heartbeat count is 14, your heart rate is 140 beats per minute. (A six second count is used because your heart rate will drop rapidly when you stop exercising).

Adjust the intensity of your exercise until your heart rate is at the proper level.

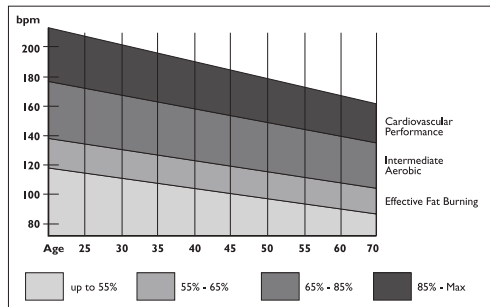
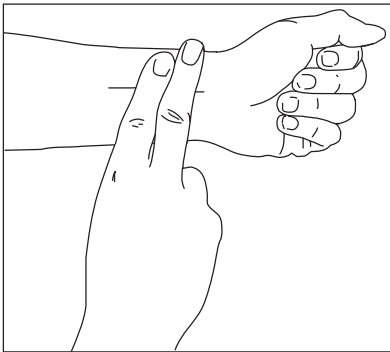

2 YEAR LIMITED WARRANTY

The Manufacturer hereby provides a warranty to the original purchaser of this product ('the Consumer') that this product will be free of manufacturing defects in materials and workmanship which under normal, personal, family or household use (commercial use expressly excluded) manifest themselves within the 2 years from the date of purchase.

EXCLUSIONS

- The warranty does not include and will not be construed to cover products damaged as a result of disaster, misuse, commercial use, not in accordance within the written instructions included with the product, abuse and/or any non-authorized modification of the product, incorrect installation of the product or normal wear and tear.
- All demo models carry a 3 month warranty.

WAIVER

The warranty and the obligations of the Manufacturer provided herein are in lieu of, and the consumer, waives all other warranties, guarantees, conditions or liabilities, express or implied, arising by law or otherwise, including without limitation, any obligation of the manufacturer in respect of any injury, loss or damage (direct, indirect or consequential) arising out of the use of, or inability to use this product and whether or not occasioned by the manufacturer's negligence or any act or omission on its part.

PROOF OF PURCHASE

Any claim in terms of the warranty must be supported by a proof of purchase or a warranty number. Warranty numbers can be issued through contacting our Trojan Call Centre on 0861 Trojan (0861 876526) or online at www.trojanhealth.co.za. Customers residing outside South Africa can contact us on +27 10 206 4405. If such proof is not available, then notwithstanding anything to the contrary herein, the service agent's prevailing charges for services/repairs including call out and/or spares will be payable by the Consumer upon collection or delivery of the repaired product.

The Consumer does not need to return the product to the store. The Consumer should call the Trojan Call Centre on 0861 Trojan (0861 876526). Customers residing outside South Africa can contact us on +27 10 206 4405 and the call centre will advise of the procedure. During the warranty period the product may only be serviced and/or repaired by the Manufacturer's duly authorised agent(s).

TROJAN	ATTACH RECEIPT	
CLIENT DETAILS		
NAME: _____		
EMAIL: _____	CELL: _____	
TEL(H): _____	TEL(W): _____ FAX: _____	
ADDRESS: _____		

PRODUCT DETAILS		
DATE OF PURCHASE: dd / mm / yy	SERIAL NUMBER: _____	TILL SLIP NUMBER: _____
DESCRIPTION OF PURCHASE: _____		

BRANCH PURCHASED AT		

0861 TROJAN (0861 876526) / +27 10 206 4405	WWW.TROJANHEALTH.CO.ZA	

REPAIRS PROCEDURE

Should you experience any faults or breakdowns on your Trojan equipment, please adhere to the following procedure to have the fault rectified speedily and professionally.

Do not return the product to the store.

Call the Trojan Call Centre on 0861 Trojan (0861 876526) to log the faulty product (under warranty or out of warranty). Customers residing outside South Africa can contact us on +27 10 206 4405.

The operator or technical advisor will try identify the fault, and will book a service team call out.

The service team will endeavour to fix the problem in your home on an agreed date and time.

Only if the fault cannot be repaired in the convenience of your home, will the service team take the faulty product back to the service centre.

Items repaired in our service centre will be returned to your home on an agreed date and time.

Note: Should you live in an outlying area or outside South Africa, it may be necessary to return the product to the store nearest to you. Our service operator will advise you of your repair procedure.

COST OF REPAIRS

UNDER WARRANTY

Any items still under warranty will be repaired free of charge, as long as it complies with the terms and conditions of the warranty (refer to “warranties” section in this manual). Any items that need to be repaired that are NOT covered in the warranty will be for the consumer’s expense. A quote for the repair/replacement of these items will be provided to the consumer for approval prior to repairs being conducted.

OUT OF WARRANTY

Any items that need to be repaired once the warranty has expired will be for the consumer’s expense including call out fees.

A quote for the repair/replacement of these items will be provided to the consumer for approval prior to repairs being conducted.

2 YEAR WARRANTY

If this product proves to be faulty during normal use due to defective materials or workmanship. Refere to our website for terms and conditions.

 **0861 876 526**
0861 TROJAN
+27 10 206 4405

Please call us for any product queries, after sales support, repairs or installations.

Manufactured for Masstores (Pty) Ltd.

16 Peltier Drive, Sunninghill, Ext 6, Sandton, 2146, South Africa

MADE IN CHINA

Always consult a physician before starting a new exercise routine

Use in conjunction with a healthy eating plan

Only use product for its intended purpose to prevent injury

#20M07T001