



DUMBBELL 200 BENCH



BENCH CARE INSTRUCTIONS AND ASSEMBLY MANUAL

CAUTION

READ ALL PRECAUTIONS AND
INSTRUCTIONS IN THIS MANUAL
BEFORE USING THIS EQUIPMENT
KEEP THIS MANUAL FOR
FUTURE REFERENCE



INDEX	PAGE
1. SAFETY INSTRUCTIONS	3
2. PRE ASSEMBLY CHECK LIST	4
3. HARDWARE LIST	5
4. PARTS LIST	6
5. ASSEMBLY STEPS	7
6. CONDITIONING GUIDELINES	9
7. WARM-UP AND COOL-DOWN	10
8. EXERCISE PROGRAMME	11
9. FREQUENTLY ASKED QUESTIONS	15
10. EXPLODED DRAWING	16
11. TROJAN 1 YEAR LIMITED WARRANTY	17
12. TROJAN REPAIRS PROCEDURE	19

1. SAFETY INSTRUCTIONS

WARNING :

To reduce the risk of serious injury, read the following safety Instructions before using the TROJAN DUMBBELL 200 BENCH.

1. Use the TROJAN DUMBBELL 200 BENCH only on a level surface.
2. Keep children and pets away from this equipment at all times.
3. The TROJAN DUMBBELL 200 BENCH has a total load capacity of 200kg (Combined weight of user and weights)
4. The TROJAN DUMBBELL 200 BENCH should be used by only one person at a time.
5. Be careful to maintain your balance while using, mounting, dismounting, folding, unfolding or assembling the TROJAN DUMBBELL 200 BENCH, loss of balance may result in a fall and serious bodily injury.
6. Use the TROJAN DUMBBELL 200 BENCH only as described in the manual.
7. Do not attempt to adjust the back rest cushion while you are on the TROJAN DUMBBELL 200 BENCH.
8. Before using this equipment to exercise, always do stretching exercises to properly warm up.
9. Always make sure all bolts and nuts are tightened prior to each use.



WARNING

Before starting any exercise or conditioning program you should consult with your personal physician to see if you require a complete physical exam. This is especially important if you are over the age of 35, have never exercised before, are pregnant, or suffer from any illness.

2. PRE ASSEMBLY CHECKLIST

Thank you for choosing the TROJAN DUMBBELL 200 BENCH. We take great pride in producing this quality product and hope it will provide many hours of quality exercise to make you feel better, look better and enjoy life to its fullest.







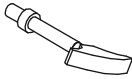

Yes, it's a proven fact that a regular exercise program can improve your physical and mental health. Too often, our busy lifestyles limit our time and opportunity to exercise. The TROJAN DUMBBELL 200 BENCH provides a convenient and simple method to begin your assault on getting your body in shape and achieving a healthier lifestyle.

Before reading further, please review the drawing below and familiarize yourself with the parts that are labeled.

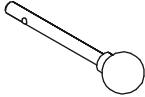
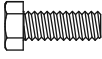
- Read this manual carefully before using the TROJAN DUMBBELL 200 BENCH.

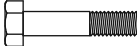
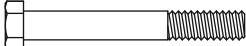

3. HARDWARE LIST

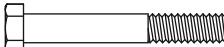
No.	Description	Q'ty	No.	Description	Q'ty
13B	 Pop Pin	1	26B	 Locknut (3/8")	5
14B	 Knob Pin	1	24B	 Hex Bolt (3/8" x 3/4")	6
15B	 Knob Nut	1	27B	 Washer (3/8")	16
21B	 Hex Bolt (3/8" x 6-1/8")	2	25B	 Hex Bolt (M8 x 38mm)	8
22B	 Hex Bolt (3/8" x 2-7/8")	1	28B	 Washer (m8)	8
23B	 Hex Bolt (3/8" x 2-5/8")	2			

NOTE :

The described parts are all you need to assemble this machine.

Before starting assembly, please check the hardware packing to make sure they are included.

4. PARTS LIST

No.	Description	Q'ty	No.	Description	Q'ty
1400-01	Center Support Frame	1	1400-15	Knob Nut	1
1400-02	Back Support Frame	1	1400-16	Round End Plug (ø25)	2
1400-03A	Front Stabilizer Feet	1	1400-17	Round End Cap (ø50)	4
1400-03B	Rear Stabilizer Feet	1	1400-18	Square End Plug (25mm)	8
1400-04	Glideframe	1	1400-18A	Square End Plug (38mm)	1
1400-05	Backrest Adjustable	1	1400-19	Square Bushing (60 x 50mm)	2
1400-06	Seat Support Frame	2	1400-20	Foam Roll	2
1400-07	Backrest Support	2	1400-21	Hex Bolt (3/8" x 6-1/8")	2
1400-08	Seat Cushion	1	1400-22	Hex Bolt (3/8" x 27/8")	1
1400-09	Backrest Cushion	1	1400-23	Hex Bolt (3/8" x 25/8")	2
1400-10	Seatadjustable Frame	1	1400-24	Hex Bolt (3/8" x 3/4")	6
1400-11	Foam Rod Support	1	1400-25	Hex Bolt (M8 x 38mm)	8
1400-11A	Foamrod	1	1400-26	Lock Nut (3/8")	5
1400-12	Bushing	4	1400-27	Washer (3/8")	16
1400-13	Pop Pin	1	1400-28	Washer (M8)	8
1400-14	Knob Pin	1			

5. ASSEMBLY STEPS

STEP 01

- Attach the Center Support Frame (1) to the Back Support Frame (2) and secure using two Hex Bolts (23), four Washers (27) and two Locknuts (26).
- Attach one Square Bushing (19) onto each end of the Glide Frame (4) and slide it onto the Back Support Frame (2)
- Lock the Glide Frame (4) into place using the Pop Pin (13).
- Place a Round Cap (17) onto each end of the Front Stabilizer Feet (3A) and Rear Stabilizer Feet (3B) and attach to the Support Frames (1, 2) using six Hex Bolts (24) and six Washers (27).
- Insert Foam Rod (11A) into holes of Foam Rod Support (11) attach Foam Rod Support (11) to the Center Support Frame (1) at desired level using the Knob Nut (15). Slide one Foam Roll (20) onto each end of the Foam Rod (11).

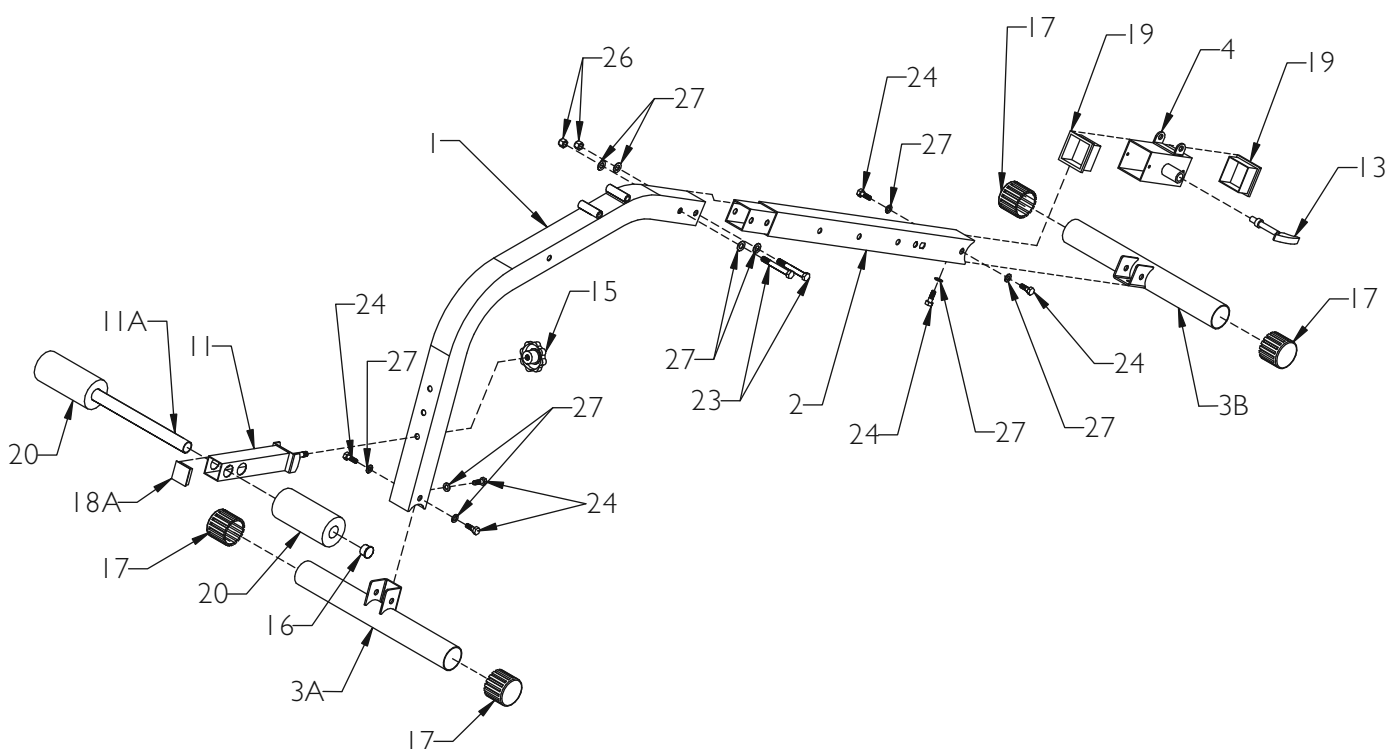

ASSEMBLY STEPS

STEP 02

- Attach the Backrest Adjustable Frame (5) to the Glide Frame (4) and secure with 1 Hex Bolt (22) , two Washers (27) and one Locknut (26).
- Attach the Adjustable Seat Frame (10) to the Center Support Frame (1) at desired height level using one Knob Pin (14).
- Insert one Square End Plug (18) into each end of the Seat Support Frame (6).
- Using one Hex Bolt (21) two Bushings (12) two Washers (27) and one Locknut (26) attach the ends of the Seat Support Frames (6) to the outsides of the bottom cylinder hole located on top of the Center Support Frame (1).
- Slide the ends of the Adjustable Seat Frame (10) into the middle holes of the Seat Support Frames (6).
- Attach the Seat Cushion (8) to the Seat Support Frames (6) using four Hex Bolts (25) and four Washers (28).
- Insert 1" Square End Plug (18) into both end of Backrest Support Frame (7).
- Fit holes in Backrest Support Frame (7) around welded rod on Center Support Frame (1).
- Place Backrest Adjustable Frame (5) between both Backrest Support Frame (7).
- Attach Backrest Cushion (9) onto Backrest Support Frame (7) using M8X38mm Hex Bolt (25) and M8 Washer(28)
- Place Backrest Adjustable Frame (5) into Glide Frame (4) and lock into Glide Frame (4) with 3/8"x2-5/8" Hex Bolt (22), 3/8" Washer (27) and 3/8" Lock Nut (26).

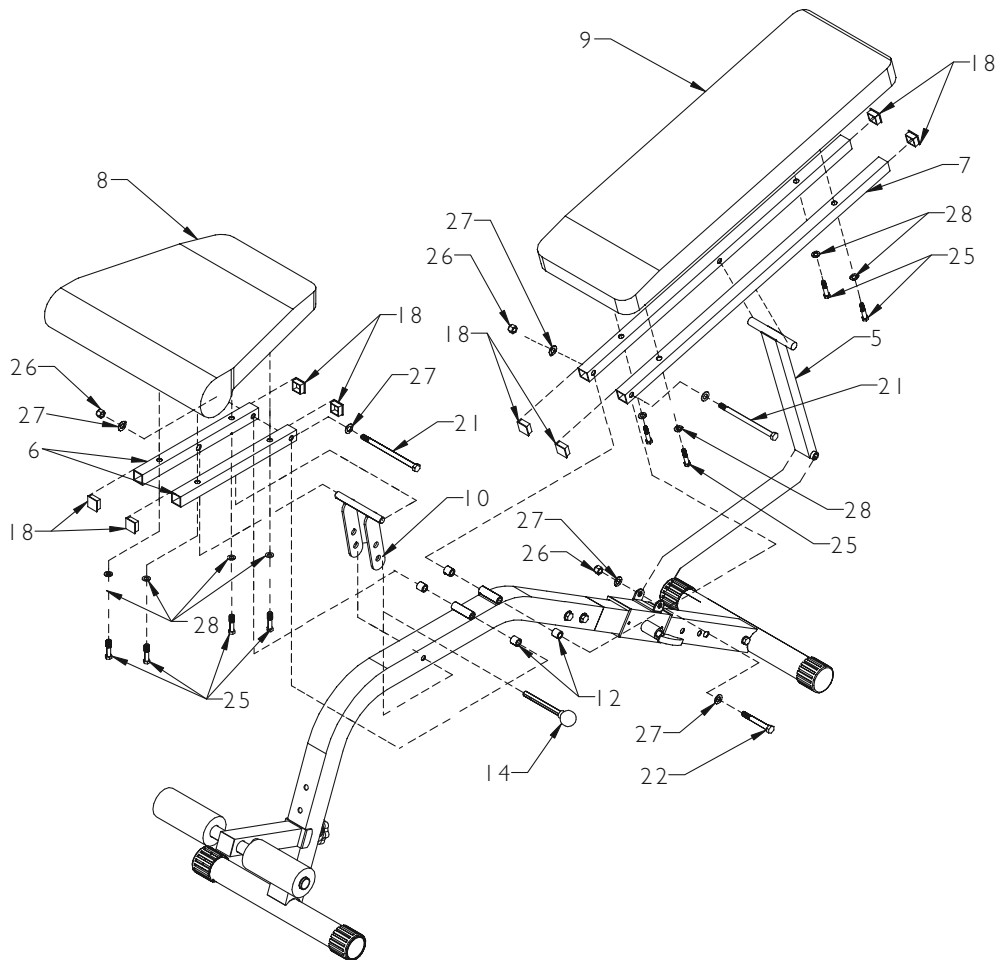

6. CONDITIONING GUIDELINES

How you begin your exercise program depends on your physical condition. If you have been inactive for several years, or are severely overweight, you must start slowly and increase your time on the equipment; a few minutes per workout.

Initially, you may be able to exercise only for a few minutes in your target zone, however, your aerobic fitness will improve over the next six to eight weeks. Don't be discouraged if it takes longer. It's important to work at your own pace. Ultimately, you'll be able to exercise continuously for 30 minutes. The better your aerobic fitness, the harder you will have to work to stay in your target zone. Please remember these essentials :

- Have your doctor review your training and diet programs to advise you of a workout routine you should adopt.
- Begin your training program slowly with realistic goals that have been set by you and your doctor.
- Monitor your pulse frequently. Establish your target heart rate based on your age and condition.
- Set up your equipment on a flat, even surface at least 3 feet from walls and furniture.

EXERCISE INTENSITY

To maximize the benefits of exercising, it is important to exercise with the proper intensity. The proper intensity level can be found by using your heart rate as a guide. For effective aerobic exercise, your heart rate should be maintained at a level between 65% and 85% of your maximum heart rate as you exercise. This is known as your target zone. You can find your target zone in the table below.

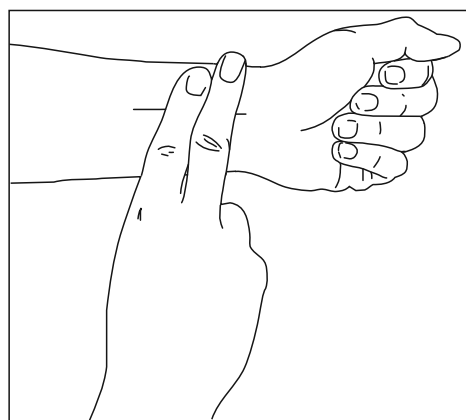

During the first few months of your exercise program, keep your heart rate near the low end of your target zone as you exercise. After a few months, your heart rate can be increased gradually until it is near the middle of your target zone as you exercise.

To measure your heart rate, stop exercising but continue moving your legs or walking around and place two fingers on your wrist. Take a six-second heartbeat count and multiply the results by 10 to find your heart rate. For example, if your six-second heartbeat count is 14, your heart rate is 140 beats per minute. (A six-second count is used because your heart rate will drop rapidly when you stop exercising.)

Adjust the intensity of your exercise until your heart rate is at the proper level.

For more information on dieting and training visit www.trojanhealth.co.za

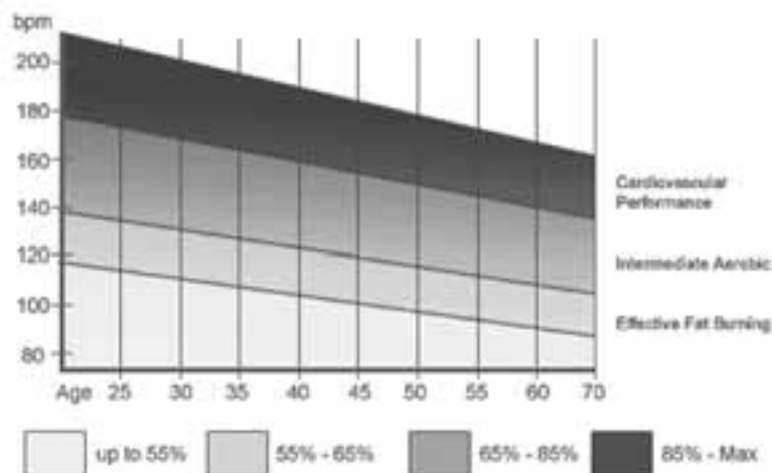

7. WARM-UP AND COOL-DOWN

WORKOUT GUIDELINES

Each workout should include the following three parts:

A warm-up, consisting of 5 to 10 minutes of stretching and light exercise. A proper warm-up increases your body temperature, heart rate, and circulation in preparation for exercise.

Training zone exercise, consisting of 20 to 30 minutes of exercising with your heart rate in your training zone. (Note: During the first few weeks of your exercise program, do not keep your heart rate in your training zone for longer than 20 minutes.)

A cool-down, with 5 to 10 minutes of stretching. This will increase the flexibility of your muscles and will help to prevent post-exercise problems.

EXERCISE FREQUENCY

To maintain or improve your condition, plan three workouts each week, with at least one day of rest between workouts. After a few months of regular exercise, you may complete up to five workouts each week, if desired. Remember, the key to success is make exercise a regular and enjoyable part of your everyday life.

SUGGESTED STRETCHES

The correct form for several basic stretches is shown at the right. Move slowly as you stretch-never bounce.

1. Toe Touch Stretch

Stand with your knees bent slightly and slowly bend forward from your hips. Allow your back and shoulders to relax as you reach down toward your toes as far as possible. Hold for 15 counts, then relax. Repeat 3 times. Stretches: Hamstrings, back of knees and back.

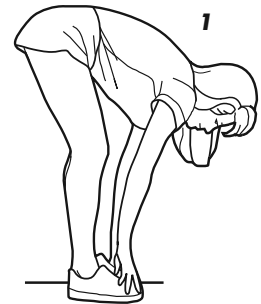

2. Hamstring Stretch

Sit with one leg extended. Bring the sole of the opposite foot toward you and rest it against the inner thigh of your extended leg. Reach toward your toes as far as possible. Hold for 15 counts, then relax. Repeat 3 times for each leg. Stretches: Hamstrings, lower back and groin.

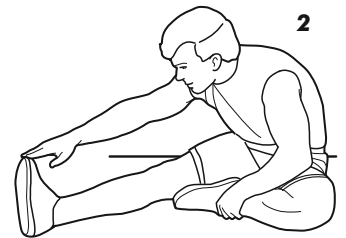

3. Calf/Achilles Stretch

With one leg in front of the other, reach forward and place your hands against a wall. Keep your back leg straight and your back foot flat on the floor. Bend your front leg, lean forward and move your hips toward the wall. Hold for 15 counts, then relax. Repeat 3 times for each leg. To cause further stretching of the achilles tendons, bend your back leg as well. Stretches: Calves, achilles tendons and ankles.

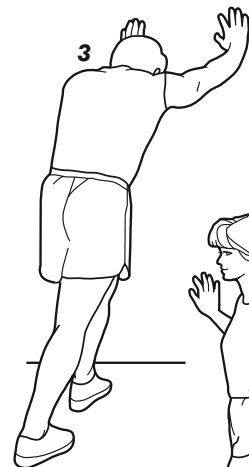

4. Quadriceps Stretch

With one hand against a wall for balance, reach back and grasp one foot with your other hand. Bring your heel as close to your buttocks as possible. Hold for 15 counts, then relax. Repeat 3 times for each leg. Stretches: Quadriceps and hip muscles.

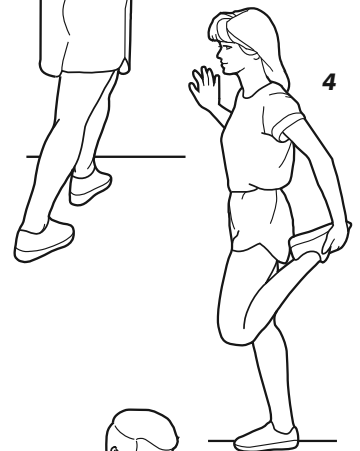

5. Inner Thigh Stretch

Sit with the soles of your feet together and your knees outward. Pull your feet toward your groin area as far as possible. Hold for 15 counts, then relax. Repeat 3 times. Stretches: Quadriceps and hip muscles.



For more information on dieting and training visit www.trojanhealth.co.za

8. EXERCISE PROGRAM

DEVELOPING AN EXERCISE PROGRAMME

For the first month of training you should allow your body to adjust to its new workload. For the 2 to 4 weeks you should only perform one work set of each exercise, only increasing the number of sets you perform after this adjustment period.

Develop your workout according to the time available to you and remember, the more effort you put in, the greater the benefits and the quicker you will see results.

DIET

Diet is a very important aspect of any fitness programme. A balanced diet will help you get to your goal weight.

For tips on diet, check out our website www.trojanhealth.co.za

EXERCISE TECHNIQUE

Hand Grips

There are two styles of handgrips that can be used when exercising:

- Overhand Grip

The bar is gripped with the hands reaching over the top of the bar and the palms facing in towards the body

- Underhand Grip

The bar is gripped with the hands reaching under the bar and the palms facing away from the body.

Breathing

Breathing at the correct time is an important part of weight training. Breathe out while you are putting the effort into the movement, i.e. when you are lifting or pushing the weight. Breathe in on the return movement or the part of the movement that requires the least effort. Never hold your breathe during an exercise.

Exercise Style

All exercises should be done in a controlled manner. Do not jerk the weight around as this can lead to injury as well as limiting the benefit of the exercise.

THE WORKOUT

The Warm Up

Always warm up thoroughly before each workout session to help minimise the risk of injury. Warm up on any Trojan exercise bike or treadmill or any other similar machine.

Weekly Routine

Perform a weight training routine 3 times per week, ensuring a day of rest and recovery between sessions.

EXERCISE PROGRAM

Reps and Sets

Repetitions (Reps) is the term used to denote the number of consecutive times a certain movement is repeated without a break, while Sets denotes how many times you should repeat that exercise in a training session e.g. 3 sets of 10 reps means you should perform 10 reps for 1 set, have a break and then repeat another 2 sets.

Recommended rep ranges

6-8 reps Functional strength and hypertrophy (increase in muscle size)

8-12 reps Total hypertrophy (increase in muscles size)

12-15 reps Muscle-Strength endurance

SAFE USE OF YOUR EQUIPMENT

When using a barbell always ensure that there is someone to help you if you get into any difficulty on an exercise specifically when bench pressing, shoulder pressing or squatting. As you start using heavier weights, it is advised that you train with someone as you can help each other out while training and motivate one another to achieve your goals.

Do's and Don'ts

- Do make sure that your weights are firmly clamped to the bar.
- Do seek medical advice before starting any exercise programme.
- Do start off slowly to avoid unnecessary soreness and stiffness.
- Do remember to bend at the knees when lifting heavy weights from the floor.
- Do maintain a firm, straight back when lifting weights.
- Do remember to breath properly.
- Do warm up thoroughly before exercising.
- Don't exercise within 2 hours of eating a large meal.
- Do ensure that there is someone to help you when you lift heavy weights.

HOW TO ASSEMBLE A DUMBBELL AND BARBELL

Load the desired weights onto the bar making sure that there is equal weight at each end. Next fit and lock the collars next to the weights so that they do not slide along the bar.

To fit quick release collars follow the procedure below:

1. Place the collar onto the ends of the bar so that they butt up to the weights
2. Turn the levers so that they line up with the bolts but point away from the collars
3. Tighten the nut until the collar is a tight fit on the bar but is still able to slide along the bar.
4. Rotate the lever so that it folds under the bar, pointing in the opposite direction to how it started (step 2).

EXERCISE PROGRAM

START POSITION



SEATED DUMBBELL CURL

Adjust bench to incline position. Curl dumbbell towards your shoulders, using only your biceps. Return the dumbbells in a controlled manner to the start position.

FINISH POSITION



DECLINE DUMBBELL PRESS

Adjust bench to decline position. Press dumbbells up and slightly towards each other. Return the dumbbells in a controlled manner to the start position.

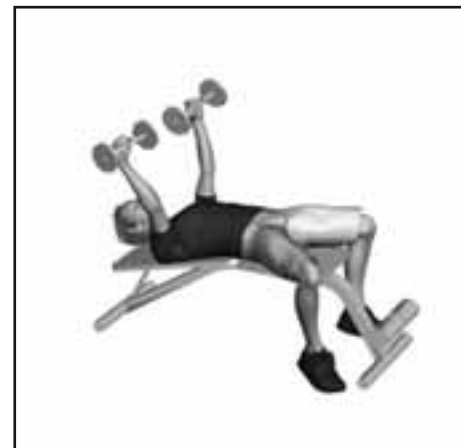

INCLINE DUMBBELL PRESS

Adjust bench to incline position. Press dumbbells up and slightly forward and towards each other. Return the dumbbells in a controlled manner to the start position.



EXERCISE PROGRAM

START POSITION

FINISH POSITION



FLAT DUMBBELL PRESS

Adjust bench to flat position.
Press dumbbells up and slightly towards each other.
Return the dumbbells in a controlled manner to the start position.



DUMBBELL FLYES

Adjust bench to flat position.
Hold dumbbells above chest with arms extended. Slowly lower arms to your sides with your palms facing inwards. Return the dumbbells in a controlled manner to the start position.



9. FREQUENTLY ASKED QUESTIONS

Q1. How do I maintain my cables?

1. The cables work in conjunction with the pulleys. When assembling the unit; make sure not to over tighten the pulleys. The pulleys are meant to move freely.
2. Before your workout; make sure all the cables are lined up correctly on the pulleys.

Q2. My moveable parts are not moving freely?

1. Make sure not to over tighten the oil bushes as the butterfly arms have to move freely.
2. Do not over tighten any bolt or nut which has bushes and moveable parts

Q3. My weight stack is not moving freely

1. Apply a light coating of grease to the guide tubes, as this will help reduce any unnecessary friction.

Q4. Is it possible to leave my weights on the bench once I have finished my workout?

1. It is not advisable as this could cause injury or cause the bench to fall over.

Q5. Is it possible to secure my bench to the ground?

1. Yes, provided that the area in which you are going to secure it is going to be in a permanent location and that the floors are not tiled

Q6. My bench is not stable

1. Ensure that all bolts are tightened and that all the end caps are on legs.

Q7. Is it a good idea to use my bench in a commercial gym?

1. No, as it is for domestic use only.

10. EXPLODED DRAWING

11. TROJAN 1 YEAR LIMITED WARRANTY

Masstores (Pty)Ltd ("the Supplier") hereby provides a limited warranty to the original purchaser of this product ("the Consumer") that this product will be free of manufacturing defects in materials and workmanship which under normal, personal, family or household use (commercial use expressly excluded) manifest themselves within the following stipulated periods from the date of purchase:

Exclusions

The warranty does not include and will not be construed to cover products damaged as a result of disaster; misuse; commercial use; use not in accordance with the written instructions included with the product; abuse; and/or any non-authorized modification of the product. It also does not cover replacement of the light bulbs and other expendables. All demo models carry a 3 month warranty.

Waiver

The warranty provided herein and the obligations of the Supplier are in lieu of, and the Customer waives, all other warranties, guarantees, conditions or liabilities, express or implied, arising by law or otherwise, including without limitation, any obligation of the Supplier in respect of any injury, loss or damage (direct, indirect or consequential) arising out of the use of, or inability to use, this product and whether or not occasioned by the Supplier's negligence or any act or omission on its part.

Claims under 1 Year Limited Warranty

Within 7 days of purchase:

The faulty product will be exchanged (provided that the product is in its original packaging with all accessories).

After 7 days but within 3 months of purchase:

The Supplier may in its sole discretion either replace or repair the product.

After 3 months but within 1 year of purchase:

The Supplier may in its sole discretion either replace or repair the product. The following shall not be covered:

- **Treadmills:** Running Decks, Running Belts, and Rubber Arm covers
- **Exercise Bikes/Spinners:** Pedals, Cranks, and Rubber Arm covers
- **Cross Trainers/ Ellipticals/ Steppers:** Foot Rests, Cranks, Shocks, and Rubber/Foam Arm covers
- **Home Gyms / Benches:** Pulleys, Cables, Seats and Padding
- **Trampolines:** Springs, Mats, and Covers
- **Rowers:** Rowing Strap / Rope / Arms, Pulling Handle, Grip, Moveable Seat

Parts not mentioned in the above, are covered under warranty within the 1st year of purchase



Proof of Purchase

Any claim in terms of the warranty must be supported by a proof of purchase or a warranty number. Warranty numbers can be issued through contacting our call centre on 0861 Trojan (0861 876 526), or online at www.trojanhealth.co.za. If such proof is not available, then notwithstanding anything to the contrary herein, the service agent's prevailing charges for services/repairs including call-out and/or spares will be payable by the Consumer upon collection or delivery of the repaired product.

The Consumer does not need to return the product to the store.

The Consumer shall phone the Trojan hotline on 0861 Trojan (0861 876 526) and the Supplier's authorized agent will at its discretion either repair the item at the Consumer's residence or collect and repair the item at their premises.

During the warranty period the product may only be serviced and/or repaired by the Supplier's duly authorized agent(s).

	ATTACH RECEIPT	
CLIENT DETAILS		
NAME: _____		
EMAIL: _____	CELL: _____	
TEL(H): _____	TEL(W) _____ FAX _____	
ADDRESS: _____		
PRODUCT DETAILS		
DATE OF PURCHASE: dd / mm / yy	SERIAL NUMBER: _____	TILL SLIP NUMBER: _____
DISCRIPTION OF PRODUCT		
BRANCH PURCHASED AT		
0861 TROJAN (0861 876526)	WWW.TROJANHEALTH.CO.ZA	



Masstores (Pty) Ltd
16 Peltier Drive, Sunninghill
Sandton, Johannesburg, South Africa

12. TROJAN REPAIRS PROCEDURE

1. Procedure for repairs

Should you experience any faults or breakdowns on your Trojan equipment, please adhere to the following procedure to have the fault rectified speedily and professionally.

- Do not return the product to the store*
- Call 0861 Trojan (0861 876526) to log the faulty product (under warranty or out of warranty)
- The operator or technical advisor will try identify the fault, and will book a service team call out.
- The service team will endeavour to fix the problem in your home on an agreed date and time.
- Only if the fault cannot be repaired in the convenience of your home, will the service team take the faulty product back to the service centre.
- Items repaired in our service centre will be returned to your home on an agreed date and time.

*** Note:**

Should you live in an outlying area, it may be necessary to return the product to the store nearest to you. Our service operator will advise you of your repair procedure.

2. Cost of Repairs

2.1 Under warranty

- Any items still under warranty will be repaired free of charge, as long as it complies with the terms and conditions of the warranty. (refer to “warranties” section in this manual)
- Any items that need to be repaired that are NOT covered in the warranty will be for the consumer's expense. A quote for the repair/replacement of these items will be provided to the consumer for approval prior to repairs being conducted.

2.2 Out of Warranty

- Any items that need to be repaired once the warranty has expired will be for the consumer's expense including call out fees. A quote for the repair/replacement of these items will be provided to the consumer for approval prior to repairs being conducted.



GET IT FIXED AT YOUR HOME OR OURS

For immediate help with assembly or for additional product information, please call our help line.
No need to return this product to the store.

Our Customer Service Department is ready to provide you with friendly assistance from the convenience of your own home

WWW.TROJANHEALTH.CO.ZA

Please have your serial number ready when you call the service centre

